

LUXURY
VINYL TILE
& PLANK

The Hilltop Collection

RIGID CORE
WATERPROOF FLOORING

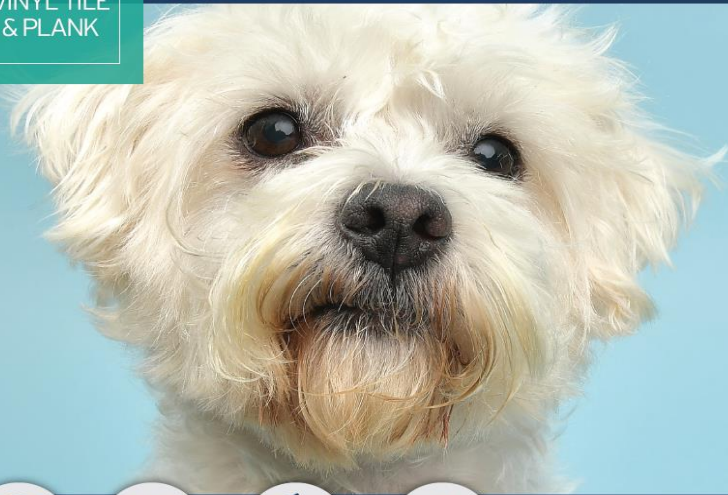

**The Best
in Flooring**

Why would you
settle for less?



Kid safe



Pet proof



Waterproof



Sound
softening



LFishman.com



Fishman Flooring Solutions is
happy to announce the new
expanded Hilltop Collection!

Hilltop Essentials

4 colors

6" x 48" x 4.7 mm

Hilltop Essentials II

4 colors

7-1/4" x 48" x 4.7 mm

Hilltop Original

8 colors

7" x 60" x 5.0 mm

Hilltop Unlimited

6 colors

7" x 61.4" x 6.0 mm

12" x 24" x 6.0 mm

Hilltop Essentials



**Lumineer
BR4-17LM**



**Stonebridge
BR4-16SB**



**Timber Lodge
BR4-15TG**

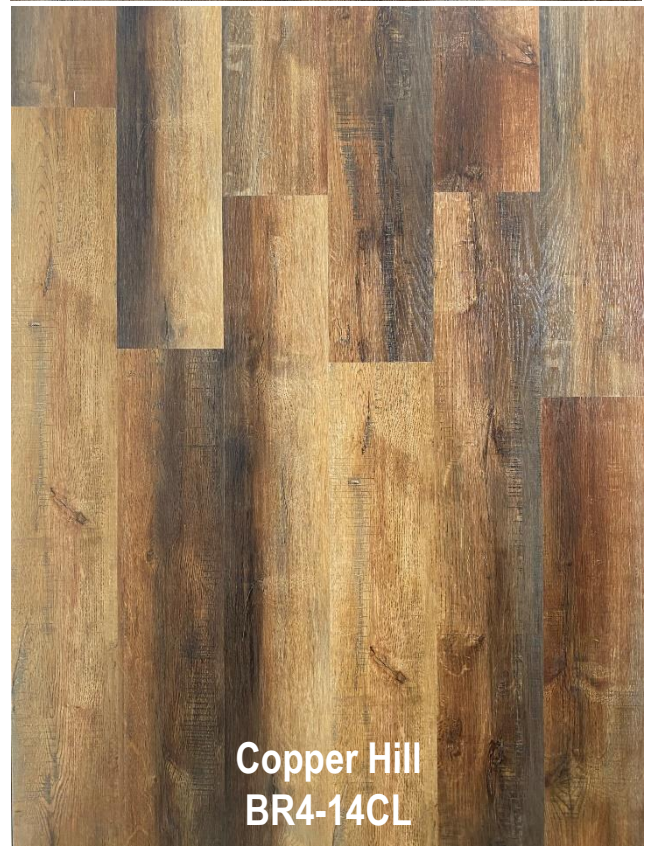

**Copper Hill
BR4-14CL**

Hilltop Essentials

Selling Features

- Hilltop **Essentials** combines 4 unique colors with texture to provide the latest styling at a budget friendly price.
- The sampling also shows off the color variation in Copper Hill and Stonebridge, which is right on trend.

SPECIFCATONS	
Plank Size	6" x 48"
Thickness	4.7 mm
Pad-Attached	1.0 mm High Density
SF / Box	23.64
STC Rating	63
IIC Rating	59
Wear Layer	20 mil
Residential Warranty	25 Year
Commercial Warranty	4 Year Limited
Locking	Valinge 2G
Finish	Aluminum Oxide
Compression	2000 lbs.
Anti-Microbial	Yes
Matching Trim	Yes

Hilltop Essentials II



North Way
VL 781 NTW



Crab Island
VL 779 SRK



Gulf Haven
CFB-GP01



Tower Beach
VL 780 CLX

Hilltop Essentials II

Selling Features

- **Hilltop Essentials II** features 4 new colors to provide the latest styling at a budget friendly price.

SPECIFCATONS	
Plank Size	7-1/4" x 48"
Thickness	4.7 mm
Pad-Attached	1.0 mm High Density
SF / Box	28.84
STC Rating	63
IIC Rating	59
Wear Layer	20 mil
Residential Warranty	25 Year
Locking	Valinge 2G
Finish	Aluminum Oxide
Compression	2000 lbs.
Anti-Microbial	Yes
Matching Trim	Yes

Hilltop Original



Bowery Point
PKR6-8BP-N-20



Rutherford
PKR6-7RD-N-20

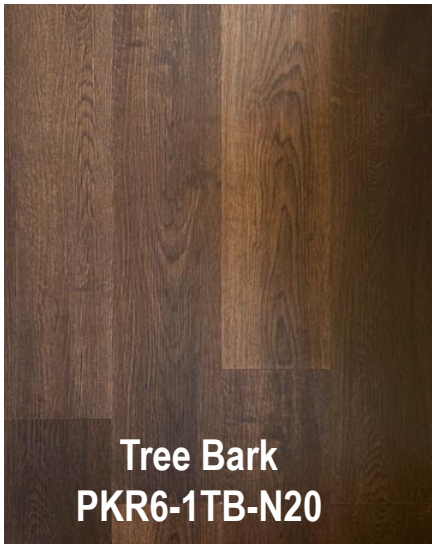

Tree Bark
PKR6-1TB-N20



Willow Creek
PKR6-6WC-N20

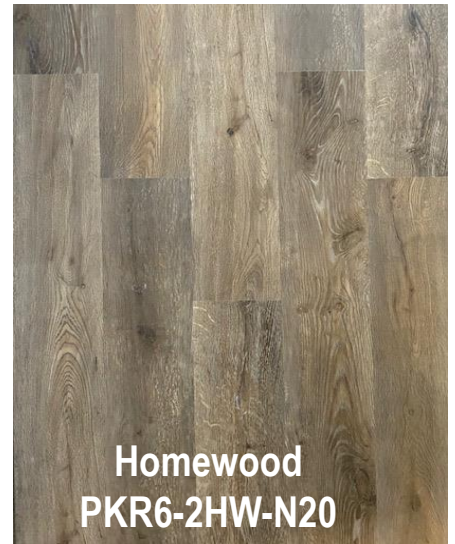

Homewood
PKR6-2HW-N20



Silver Oak
PKR6-3SV-N20



Phase Out

Manor House
PKR6-5RH-N20

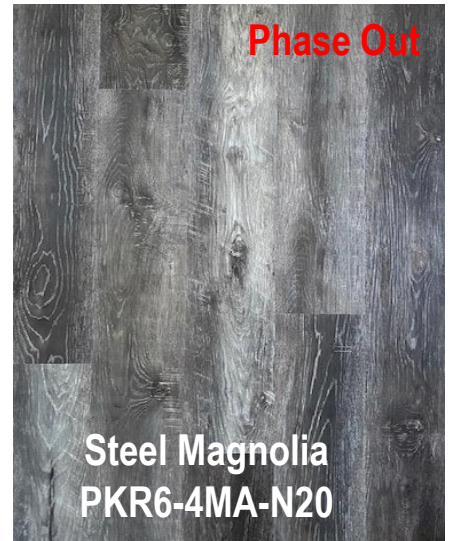

Phase Out

Steel Magnolia
PKR6-4MA-N20

Hilltop Original

Selling Features

- Hilltop **Original** is perfect for any application at an affordable price, especially with the new 20 mil wear layer.
- With its pet proof and kid friendly finish, you can rest easy knowing your flooring will last.
- The wider and longer planks give a more luxurious look in any size room!

SPECIFCATIONS	
Plank Size	7" x 60"
Thickness	5.0 mm
Pad-Attached	1.0 mm High Density
SF / Box	29.89
STC Rating	63
IIC Rating	65
Wear Layer	20 mil
Residential Warranty	Lifetime
Commercial Warranty	10 Year Limited
Locking	Unilin Angle Angle
Finish	Aluminum Oxide
Compression	2000 lbs.
Anti-Microbial	Yes
Matching Trim	Yes

Hilltop Unlimited



Bluff PKR12-12BF



Mineral PKR12-13NL



Ashland PKR7-7AN



Primrose PKR7-11PS



Rock Cress PKR7-10CK



Woodlaw PKR7-8WW

Hilltop Unlimited

Selling Features

- Hilltop **Unlimited** is the ultimate game changer with a thicker core, denser pad and painted bevels.
- The **Unlimited** also features an extremely durable *anti-scratch* coating to protect the floor from the toughest of customers.
- The BLUE pad-attached is a 1.0 mm high density IXPE to help reduce sounds transmission with a super dense closed cell design.

SPECIFCATONS

SPECIFCATONS	
Plank Size	7" x 61.4" 12" x 24"
Thickness	6.0 mm
Pad-Attached	1.0 mm High Density
SF / Box	23.61 20.03
STC Rating	66
IIC Rating	67
Wear Layer	20 mil Anti-Scratch
Residential Warranty	Lifetime
Commercial Warranty	15 Year Limited
Locking	Unilin Angle Angle
Finish	Aluminum Oxide
Compression	2000 lbs.
Anti-Microbial	Yes
Matching Trim	Yes

- The 5 new plank colors round out the line with lighter, cleaner visuals.
- TILES, TILES, TILES – You finally have 2 tile visuals to offer. Perfect for all kitchens, laundry rooms, mud rooms, etc.

Sample Venues

Hilltop Essentials I & II
Strap Sets
Double-Sided Hand Boards
Architect Folders

LUXURY VINYL TILE & PLANK

Hilltop Essential
COMMERCIAL RIGID CORE
WATERPROOF FLOORING

Specifications	
Size	6" x 46" x 5.7 mm thick
Soft per box	23.64
Wear Layer	12 mil
Finish	UV Cured
Gloss Level	8% - 10%
Construction	Wiggle SPC
High Density Pad	1.0 mm, attached
Edge Profile	4-sided Micro Bevel
Locking System	Valinge
Matching Trims	Yes
Residential Warranty	25 Year
Commercial Warranty	4 Year Limited
STC Rating	63
IC Rating	59

www.LFishman.com

The Hilltop Collection
Essential Series

WWW.HILLTOPRIGID.COM

Rigid Core: WATERPROOF Flooring
4 Year Limited Commercial Warranty
25 Year Residential Warranty
High Density Pad Attached
12 MIL Wear Layer
8% - 10% Gloss
23.64 SF/Box

Timber Lodge

Copper Hill

Hilltop Original
Strap Sets
Double-Sided Hand Boards
Architect Folders
Display Stand

The Hilltop Collection
7" x 60" x 5.0 mm thick
With High Density Pad-Attached

Rigid Core Waterproof Flooring

STC Rating	219 dB
IC Rating	61
STC Rating	60
Wear Layer	20 mil
Residential Warranty	Lifetime
Commercial Warranty	10 Year Limited
Locking	Locked
High Density Pad	EVA
Finish	Aluminum Oxide
Compression	2000 lbs
Anti-Microbial	Yes
Matching trim	Yes

www.hilltoprigid.com

- High compression rating for maximum durability
- Class 1 fire rating meets outdoor requirements
- Matching trims
- Minimal floor prep for easy installation
- 25 Year Residential Warranty
- 10 Year Light Commercial Warranty

The Hilltop Collection

WWW.HILLTOPRIGID.COM

Rigid Core: WATERPROOF Flooring
10 Year Limited Commercial Warranty
25 Year Residential Warranty
High Density Pad Attached
20 MIL Wear Layer
23.64 SF/Box

Homewood

Willow Creek

Tree Bark

Custom Fishman Architect Swing Folders – Full pieces of each color!

LUXURY VINYL TILE & PLANK

The Hilltop Collection

Hilltop Original
A Fishman Brand Product

LUXURY VINYL TILE & PLANK

Hilltop Original
COMMERCIAL SPC RIGID CORE
WATERPROOF FLOORING

Hilltop Original
7" x 60" x 5.0mm
COMMERCIAL SPC RIGID CORE
WATERPROOF FLOORING

Matching Trims available in:
T-Molding, Reducor, & Base Dado

FISHMAN BRAND PRODUCTS | L.Fishman.com | Fishman VINYL TILE & PLANK Flooring Solutions
Div. of L. Fishman & Son, Inc.

The Best in Flooring

Style, durability and performance. Hilltop Rigid Core Flooring marries technology & style together to create a timeless pairing to last for years to come. With its high resistant top layer, this easy to install click together flooring resists water and liquid and handles the toughest of traffic with ease. With a simple wipe and go method, the surface looks clean in moments. Under that tough exterior lies a beautifully realistic wood pattern and sound softening EVA pad. Why would you settle for less?

Features

- 6 available colors
- 7" x 60" x 5.0mm (20 MIL)
- Waterproof flooring
- Available matching trims
- Click system for fast, efficient installation
- Antimicrobial features
- Attached sound softening EVA pad
- Lifetime Residential Warranty
- 10 Year Commercial Warranty

Hilltop Original Collection

Color	SKU Number
Steel Oak	PH00-2000-02
Steel Magnolia	PH00-0800-02
Homewood	PH00-2100-02
Tree Bark	PH00-1100-02
Woods House	PH00-0100-02
Willow Creek	PH00-0300-02

Residential & Commercial Warranties

Anti-Microbial

Waterproof

Sound Softening

Matching Trims

Hilltop Original
Homewood

PKR6-21W '8 20

Sample Venues

Hilltop Unlimited Double-Sided Hand Boards Architect Folders Display Stand

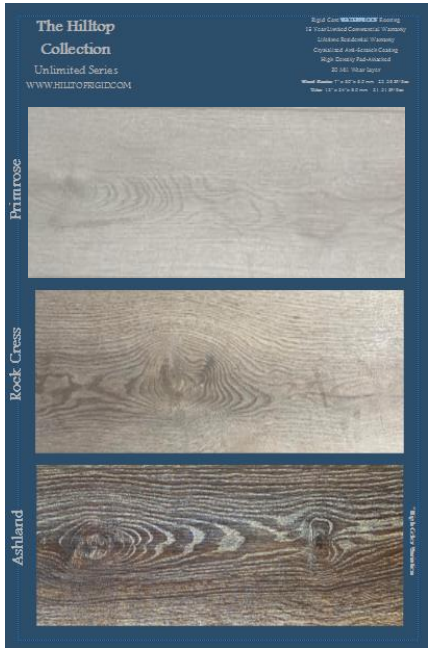

Custom Fishman Architect Swing Folders – Full pieces of each color!

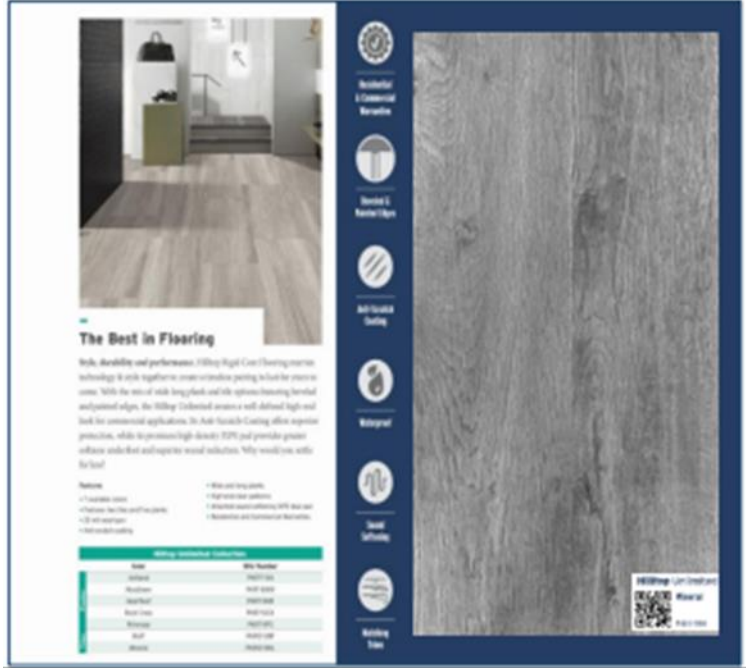

Display Stand

Hilltop Collection Display Stand

- Display includes Original and Unlimited (13 skus)
- Display includes 3 boxes for samples plus new header
- Each back label includes individual room scenes on all colors with examples below
- Two tiles from Unlimited share one sample board
- Completely customizable on labeling to match your existing marketing program



Hilltop Original
Manor House

COMMERCIAL SPC RIGID CORE
WATERPROOF FLOORING

www.LFfishman.com

Specifications

- Color Name: SCORPE WHITE
- Item Number: 101010000000
- SF/Box: 20.84
- Dimensions: 7' x 10' (68" x 120")
- Planks: 20 (10/20/20)
- Locking: Click & Lock
- Wear Layer: 30 mil
- High Density Pad: FSC
- Residential Warranty: 10 Year
- Commercial Warranty: 10 Year
- Compressions: 2000 PSI
- Anti-Microbial: Yes
- STC Rating: 65
- IC Rating: 05
- Marketing Time: Yes

COMMERCIAL SPC RIGID CORE
WATERPROOF FLOORING

www.LFfishman.com

Specifications

- Collection: HILLTOP UNLIMITED
- Color Name: ROCK CRESS
- Item Number: 101010000000
- SF/Box: 20.84
- Dimensions: 7' x 10' (68" x 120")
- Planks: 20 (10/20/20)
- Locking: Click & Lock
- Wear Layer: 30 mil
- High Density Pad: FSC
- Residential Warranty: 10 Year
- Commercial Warranty: 10 Year
- Compressions: 2000 PSI
- Anti-Microbial: Yes
- STC Rating: 65
- IC Rating: 05
- Marketing Time: Yes

COMMERCIAL SPC RIGID CORE
WATERPROOF FLOORING

www.LFfishman.com

Specifications

- Collection: HILLTOP UNLIMITED
- Color Name: ROCK CRESS
- Item Number: 101010000000
- SF/Box: 20.84
- Dimensions: 7' x 10' (68" x 120")
- Planks: 20 (10/20/20)
- Locking: Click & Lock
- Wear Layer: 30 mil
- High Density Pad: FSC
- Residential Warranty: 10 Year
- Commercial Warranty: 10 Year
- Compressions: 2000 PSI
- Anti-Microbial: Yes
- STC Rating: 65
- IC Rating: 05
- Marketing Time: Yes

COMMERCIAL SPC RIGID CORE
WATERPROOF FLOORING

Hilltop Unlimited
Rock Cress

COMMERCIAL SPC RIGID CORE
WATERPROOF FLOORING

www.LFfishman.com

Specifications

- Collection: HILLTOP UNLIMITED
- Color Name: ROCK CRESS
- Item Number: 101010000000
- SF/Box: 20.84
- Dimensions: 7' x 10' (68" x 120")
- Planks: 20 (10/20/20)
- Locking: Click & Lock
- Wear Layer: 30 mil
- High Density Pad: FSC
- Residential Warranty: 10 Year
- Commercial Warranty: 10 Year
- Compressions: 2000 PSI
- Anti-Microbial: Yes
- STC Rating: 65
- IC Rating: 05
- Marketing Time: Yes

COMMERCIAL SPC RIGID CORE
WATERPROOF FLOORING

www.LFfishman.com

Specifications

- Collection: HILLTOP UNLIMITED
- Color Name: ROCK CRESS
- Item Number: 101010000000
- SF/Box: 20.84
- Dimensions: 7' x 10' (68" x 120")
- Planks: 20 (10/20/20)
- Locking: Click & Lock
- Wear Layer: 30 mil
- High Density Pad: FSC
- Residential Warranty: 10 Year
- Commercial Warranty: 10 Year
- Compressions: 2000 PSI
- Anti-Microbial: Yes
- STC Rating: 65
- IC Rating: 05
- Marketing Time: Yes

COMMERCIAL SPC RIGID CORE
WATERPROOF FLOORING

Hilltop Unlimited
Rock Cress

COMMERCIAL SPC RIGID CORE
WATERPROOF FLOORING

www.LFfishman.com

Specifications

- Collection: HILLTOP UNLIMITED
- Color Name: ROCK CRESS
- Item Number: 101010000000
- SF/Box: 20.84
- Dimensions: 7' x 10' (68" x 120")
- Planks: 20 (10/20/20)
- Locking: Click & Lock
- Wear Layer: 30 mil
- High Density Pad: FSC
- Residential Warranty: 10 Year
- Commercial Warranty: 10 Year
- Compressions: 2000 PSI
- Anti-Microbial: Yes
- STC Rating: 65
- IC Rating: 05
- Marketing Time: Yes

COMMERCIAL SPC RIGID CORE
WATERPROOF FLOORING

www.LFfishman.com

Specifications

- Collection: HILLTOP UNLIMITED
- Color Name: ROCK CRESS
- Item Number: 101010000000
- SF/Box: 20.84
- Dimensions: 7' x 10' (68" x 120")
- Planks: 20 (10/20/20)
- Locking: Click & Lock
- Wear Layer: 30 mil
- High Density Pad: FSC
- Residential Warranty: 10 Year
- Commercial Warranty: 10 Year
- Compressions: 2000 PSI
- Anti-Microbial: Yes
- STC Rating: 65
- IC Rating: 05
- Marketing Time: Yes

COMMERCIAL SPC RIGID CORE
WATERPROOF FLOORING

Trim Profiles

Hilltop Original and Unlimited Trim

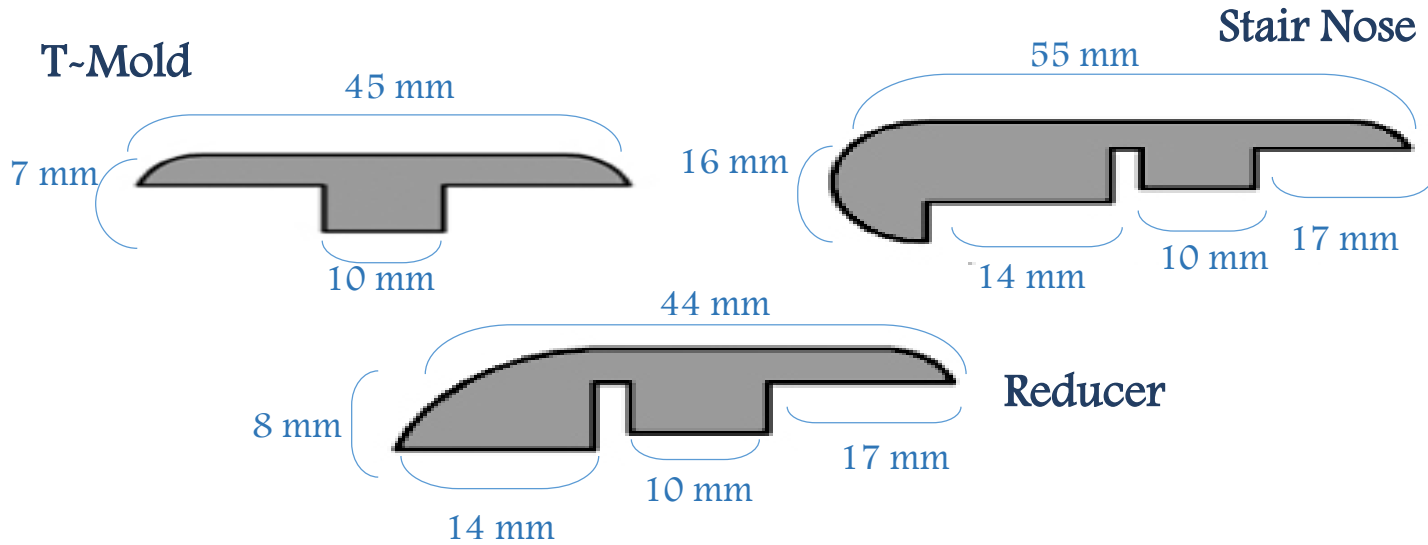

Hilltop Essentials

